

JOHN DEERE
WORLDWIDE COMMERCIAL & CONSUMER
EQUIPMENT DIVISION

Gator Utility Vehicles
4X2 and 4X6

TM1518 SEPTEMBER 2004

TECHNICAL MANUAL

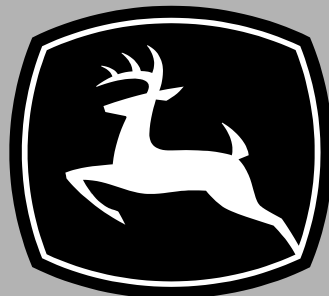

JOHN DEERE

North American Version
Litho in U.S.A.

INTRODUCTION

Manual Description

This technical manual is written for an experienced technician and contains sections that are specifically for this product. It is a part of a total product support program.

The manual is organized so that all the information on a particular system is kept together. The order of grouping is as follows:

- Table of Contents
- Specifications and Information
- Identification Numbers
- Tools and Materials
- Component Location
- Schematics and Harnesses
- Theory of Operation
- Operation and Diagnostics
- Diagnostics
- Tests and Adjustments
- Repair
- Other

NOTE: Depending on the particular section or system being covered, not all of the above groups may be used.

The bleed tabs for the pages of each section will align with the sections listed on this page. Page numbering is consecutive from the beginning of the Safety section through the last section.

We appreciate your input on this manual. If you find any errors or want to comment on the layout of the manual please contact us.

Safety

Specifications and Information

Engine - Gas (Air-Cooled)

Engine - Gas (Liquid-Cooled)

Engine - Diesel

Electrical

Power Train - Gear

Steering

Brakes

Attachments

Engine - Rotary Broom

Miscellaneous

All information, illustrations and specifications in this manual are based on the latest information at the time of publication. The right is reserved to make changes at any time without notice.

COPYRIGHT© 2004
Deere & Co.

John Deere Worldwide Commercial and
Consumer Equipment Division

All rights reserved
Previous Editions
COPYRIGHT© 2001, 2002, 2004

SAFETY

Recognize Safety Information

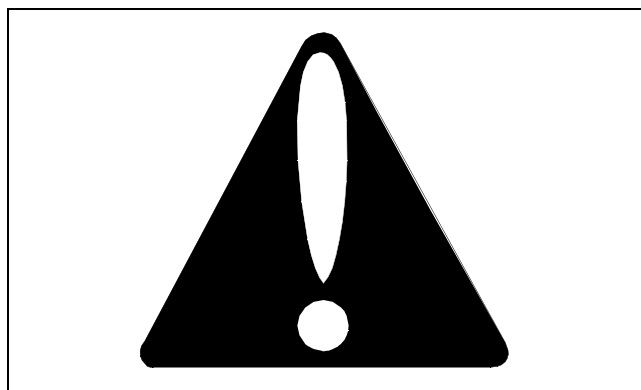

MIF

This is the safety-alert symbol. When you see this symbol on your machine or in this manual, be alert to the potential for personal injury.

Follow recommended precautions and safe servicing practices.

Understand Signal Words

A signal word - DANGER, WARNING, or CAUTION - is used with the safety-alert symbol. DANGER identifies the most serious hazards.

DANGER or WARNING safety signs are located near specific hazards. General precautions are listed on CAUTION safety signs. CAUTION also calls attention to safety messages in this manual.

Replace Safety Signs

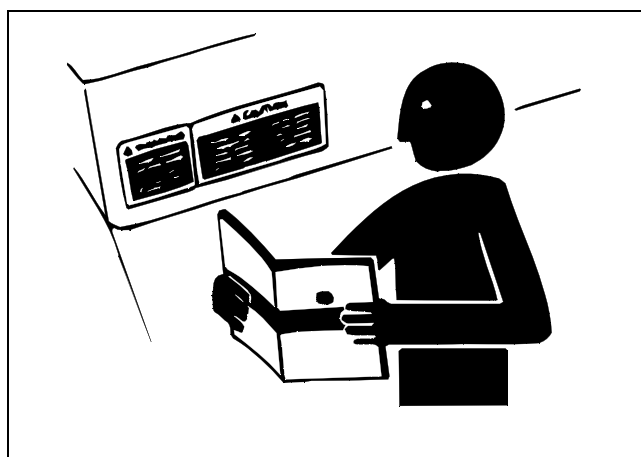

MIF

Replace missing or damaged safety signs. See the machine operator's manual for correct safety sign placement.

Handle Fluids Safely - Avoid Fires

Be Prepared For Emergencies

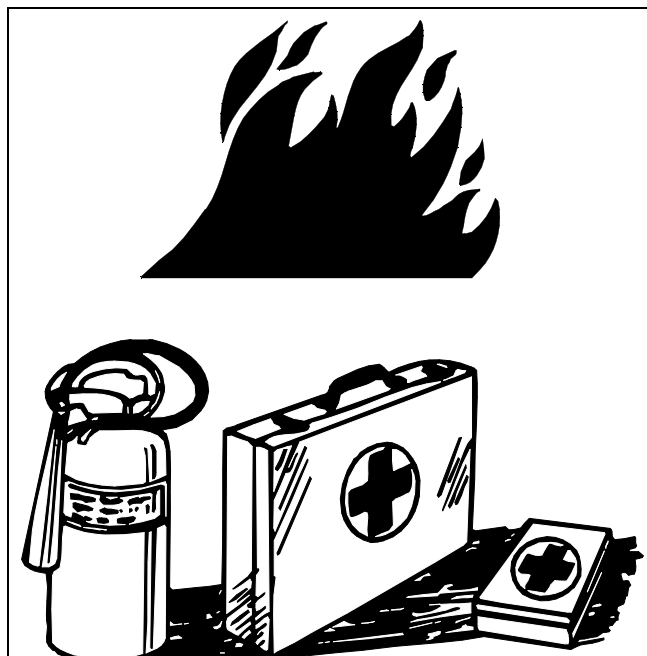

MIF

- When you work around fuel, do not smoke or work near heaters or other fire hazards.
- Store flammable fluids away from fire hazards. Do not incinerate or puncture pressurized containers.
- Make sure machine is clean of trash, grease, and debris.
- Do not store oily rags; they can ignite and burn spontaneously.
- Be prepared if a fire starts.
- Keep a first aid kit and fire extinguisher handy.
- Keep emergency numbers for doctors, ambulance service, hospital, and fire department near your telephone.

Use Care In Handling and Servicing Batteries

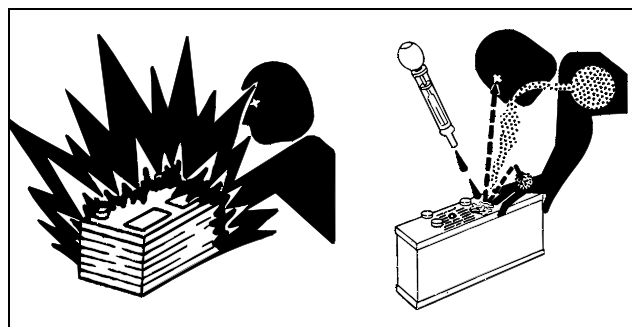

MIF

SAFETY

Prevent Battery Explosions

- Keep sparks, lighted matches, and open flame away from the top of battery. Battery gas can explode.
- Never check battery charge by placing a metal object across the posts. Use a volt-meter or hydrometer.
- Do not charge a frozen battery; it may explode. Warm battery to 16°C (60°F).

Prevent Acid Burns

- Sulfuric acid in battery electrolyte is poisonous. It is strong enough to burn skin, eat holes in clothing, and cause blindness if splashed into eyes.

Avoid acid burns by:

1. Filling batteries in a well-ventilated area.
2. Wearing eye protection and rubber gloves.
3. Avoiding breathing fumes when electrolyte is added.
4. Avoiding spilling or dripping electrolyte.
5. Use proper jump start procedure.

If you spill acid on yourself:

1. Flush your skin with water.
2. Apply baking soda or lime to help neutralize the acid.
3. Flush your eyes with water for 10 - 15 minutes.
4. Get medical attention immediately.

If acid is swallowed:

1. Drink large amounts of water or milk.
2. Then drink milk of magnesia, beaten eggs, or vegetable oil.
3. Get medical attention immediately.

Wear Protective Clothing

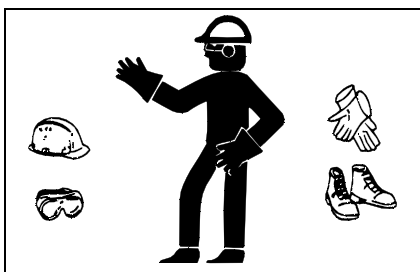

MIF

Wear close fitting clothing and safety equipment appropriate to the job.

Prolonged exposure to loud noise can cause impairment or loss of hearing. Wear a suitable hearing protective device

such as earmuffs or earplugs to protect against objectionable or uncomfortable loud noises.

Operating equipment safely requires the full attention of the operator. Do not wear radio or music headphones while operating machine.

Use Care Around High-pressure Fluid Lines

Avoid High-Pressure Fluids



MIF

Escaping fluid under pressure can penetrate the skin causing serious injury.

Avoid injury from escaping fluid under pressure by stopping the engine and relieving pressure in the system before disconnecting or connecting hydraulic or other lines. Tighten all connections before applying pressure.

Search for leaks with a piece of cardboard. Protect hands and body from high pressure fluids.

If an accident occurs, see a doctor immediately. Any fluid injected into the skin must be surgically removed within a few hours or gangrene may result. Doctors unfamiliar with this type of injury should reference a knowledgeable medical source. Such information is available from Deere & Company Medical Department in Moline, Illinois, U.S.A.

Avoid Heating Near Pressurized Fluid Lines

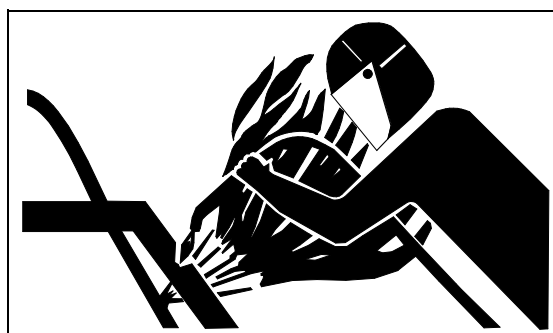

MIF

Flammable spray can be generated by heating near pressurized fluid lines, resulting in severe burns to yourself and bystanders. Do not heat by welding, soldering, or using a torch near pressurized fluid lines or other flammable materials. Pressurized lines can be accidentally cut when heat goes beyond the immediate flame area.

SAFETY

Service Machines Safely

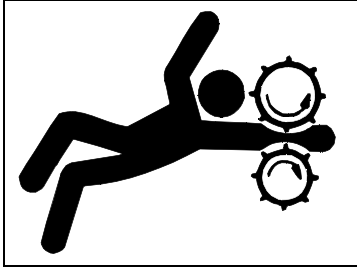

MIF

Tie long hair behind your head. Do not wear a necktie, scarf, loose clothing, or necklace when you work near machine tools or moving parts. If these items were to get caught, severe injury could result.

Remove rings and other jewelry to prevent electrical shorts and entanglement in moving parts.

Use Proper Tools

Use tools appropriate to the work. Makeshift tools and procedures can create safety hazards. Use power tools only to loosen threaded parts and fasteners. For loosening and tightening hardware, use the correct size tools. **DO NOT** use U.S. measurement tools on metric fasteners. Avoid bodily injury caused by slipping wrenches. Use only service parts meeting John Deere specifications.

Park Machine Safely

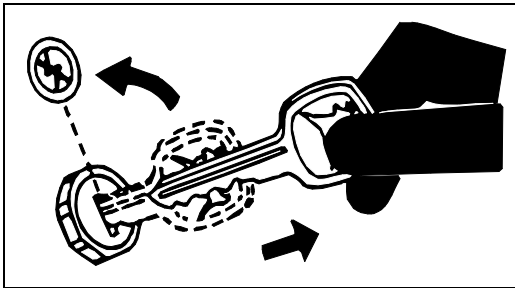

MIF

Before working on the machine:

1. Lower all equipment to the ground.
2. Stop the engine and remove the key.
3. Disconnect the battery ground strap.
4. Hang a "DO NOT OPERATE" tag in operator station.

Support Machine Properly and Use Proper Lifting Equipment

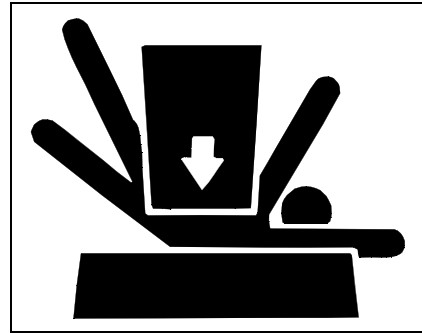

MIF

If you must work on a lifted machine or attachment, securely support the machine or attachment.

Do not support the machine on cinder blocks, hollow tiles, or props that may crumble under continuous load. Do not work under a machine that is supported solely by a jack. Follow recommended procedures in this manual.

Lifting heavy components incorrectly can cause severe injury or machine damage. Follow recommended procedure for removal and installation of components in the manual.

Work In Clean Area

Before starting a job:

1. Clean work area and machine.
2. Make sure you have all necessary tools to do your job.
3. Have the right parts on hand.
4. Read all instructions thoroughly; do not attempt shortcuts.

Using High Pressure Washers

Directing pressurized water at electronic/electrical components or connectors, bearings, hydraulic seals, fuel injection pumps or other sensitive parts and components may cause product malfunctions. Reduce pressure and spray at a 45 to 90 degree angle.

Illuminate Work Area Safely

Illuminate your work area adequately but safely. Use a portable safety light for working inside or under the machine. Make sure the bulb is enclosed by a wire cage. The hot filament of an accidentally broken bulb can ignite spilled fuel or oil.

SAFETY

Work In Ventilated Area

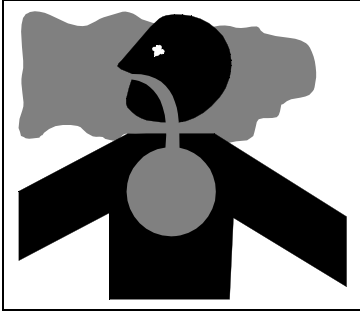

MIF

Engine exhaust fumes can cause sickness or death. If it is necessary to run an engine in an enclosed area, remove the exhaust fumes from the area with an exhaust pipe extension.

If you do not have an exhaust pipe extension, open the doors and get outside air into the area.

Warning: California Proposition 65 Warning

Gasoline engine exhaust from this product contains chemicals known to the State of California to cause cancer, birth defects, or other reproductive harm.

Diesel engine exhaust and some of its constituents are known to the State of California to cause cancer, birth defects, and other reproductive harm.

Remove Paint Before Welding or Heating

Avoid potentially toxic fumes and dust. Hazardous fumes can be generated when paint is heated by welding, soldering, or using a torch. Do all work outside or in a well ventilated area. Dispose of paint and solvent properly. Remove paint before welding or heating: If you sand or grind paint, avoid breathing the dust. Wear an approved respirator. If you use solvent or paint stripper, remove stripper with soap and water before welding. Remove solvent or paint stripper containers and other flammable material from area. Allow fumes to disperse at least 15 minutes before welding or heating.

Avoid Harmful Asbestos Dust

Avoid breathing dust that may be generated when handling components containing asbestos fibers. Inhaled asbestos fibers may cause lung cancer.

Components in products that may contain asbestos fibers are brake pads, brake band and lining assemblies, clutch plates, and some gaskets. The asbestos used in these components is usually found in a resin or sealed in some way. Normal handling is not hazardous as long as airborne dust containing asbestos is not generated.

Avoid creating dust. Never use compressed air for cleaning. Avoid brushing or grinding material containing asbestos. When servicing, wear an approved respirator. A special vacuum cleaner is recommended to clean asbestos. If not available, apply a mist of oil or water on the material containing asbestos. Keep bystanders away from the area.

Service Tires Safely



MIF

Explosive separation of a tire and rim parts can cause serious injury or death.

Do not attempt to mount a tire unless you have the proper equipment and experience to perform the job.

Always maintain the correct tire pressure. Do not inflate the tires above the recommended pressure. Never weld or heat a wheel and tire assembly. The heat can cause an increase in air pressure resulting in a tire explosion. Welding can structurally weaken or deform the wheel.

When inflating tires, use a clip-on chuck and extension hose long enough to allow you to stand to one side and NOT in front of or over the tire assembly. Use a safety cage if available.

Check wheels for low pressure, cuts, bubbles, damaged rims or missing lug bolts and nuts.

SAFETY

Avoid Injury From Rotating Blades, Augers and PTO Shafts

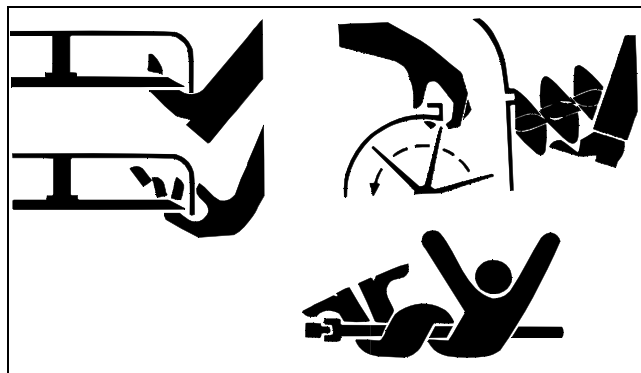

MIF

Keep hands and feet away while machine is running. Shut off power to service, lubricate or remove mower blades, augers or PTO shafts.

Service Cooling System Safely

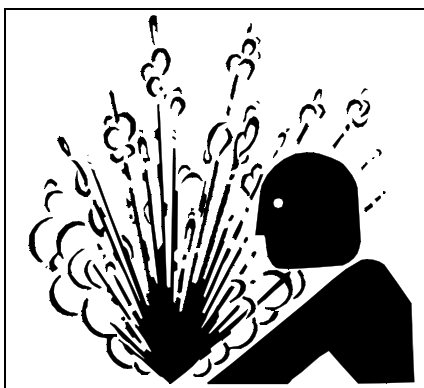

MIF

Explosive release of fluids from pressurized cooling system can cause serious burns.

Shut off machine. Only remove filler cap when cool enough to touch with bare hands. Slowly loosen cap to first stop to relieve pressure before removing completely.

Handle Chemical Products Safely

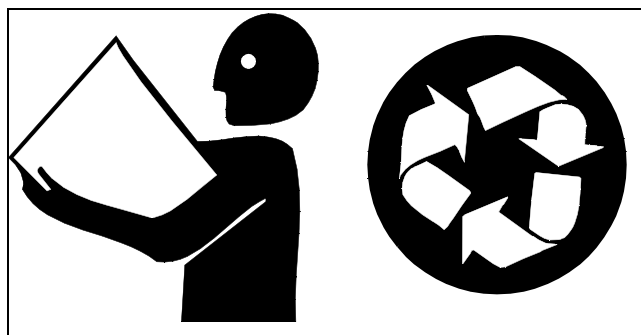

MIF

Direct exposure to hazardous chemicals can cause serious injury. Potentially hazardous chemicals used with John Deere equipment include such items as lubricants, coolants, paints, and adhesives.

A Material Safety Data Sheet (MSDS) provides specific details on chemical products: physical and health hazards, safety procedures, and emergency response techniques. Check the MSDS before you start any job using a hazardous chemical. That way you will know exactly what the risks are and how to do the job safely. Then follow procedures and recommended equipment.

Dispose of Waste Properly

Improperly disposing of waste can threaten the environment and ecology. Potentially harmful waste used with John Deere equipment include such items as oil, fuel, coolant, brake fluid, filters, and batteries. Use leakproof containers when draining fluids. Do not use food or beverage containers that may mislead someone into drinking from them. Do not pour waste onto the ground, down a drain, or into any water source. Inquire on the proper way to recycle or dispose of waste from your local environmental or recycling center, or from your John Deere dealer.

Live With Safety



MIF

Before returning machine to customer, make sure machine is functioning properly, especially the safety systems. Install all guards and shields.

SAFETY



SPECIFICATIONS & INFORMATION TABLE OF CONTENTS

Table of Contents

Fastener Torques	9
Metric Fastener Torque Values	9
Inch Fastener Torque Values	10
O-Ring Seal Service Recommendations	11
Face Seal Fittings	
With Inch Stud Ends Torque	11
Face Seal Fittings	
With Metric Stud Ends Torque	12
O-Ring Face Seal Fittings	13
O-Ring Boss Fittings	13
Straight Fitting Or Special Nut Torques.....	13
Metric Fastener Torque Value -	
Grade 7 (Special)	14
General Information	14
Gasoline	14
Gasoline Storage.....	15
4 - Cycle Gasoline Engine Oil	15
Diesel Fuel	16
Diesel Fuel Lubricity	16
Diesel Fuel Storage.....	16
Break-In Engine Oil - 4-Cycle Gasoline.....	16
4 - Cycle Diesel Engine Oil.....	17
Break-In Engine Oil - Diesel	17
Hydrostatic Transmission	
and Hydraulic Oil	18
Gear Case Oil.....	19
Gear Transmission Grease	19
Alternative Lubricants.....	19
Synthetic Lubricants	20
Lubricant Storage	20
Mixing of Lubricants	20
Oil Filters	20
Coolant Specifications	20
Gasoline Engine Coolant.....	20
Gasoline Engine Coolant Drain Interval	21
Diesel Engine Coolant.....	21
Diesel Engine Coolant Drain Interval	22
Serial Number Locations	22
Product Serial Number	22
Engine (FE290D) Serial Number Location ...	22
Engine (FE620D) Serial Number Location ...	23
Engine (3TN66C) Serial Number Location ...	23
Transaxle Serial Number Location	23

SPECIFICATIONS & INFORMATION TABLE OF CONTENTS



SPECIFICATIONS & INFORMATION FASTENER TORQUES

Fastener Torques

Metric Fastener Torque Values

Property Class and Head Markings				
Property Class and Nut Markings				

MIF

SIZE	Class 4.8				Class 8.8 or 9.8				Class 10.9				Class 12.9			
	Lubricated a		Dry a		Lubricated a		Dry a		Lubricated a		Dry a		Lubricated a		Dry a	
	N•m	lb-ft	N•m	lb-ft	N•m	lb-ft	N•m	lb-ft	N•m	lb-ft	N•m	lb-ft	N•m	lb-ft	N•m	lb-ft
M6	4.8	3.5	6	4.5	9	6.5	11	8.5	13	9.5	17	12	15	11.5	19	14.5
M8	12	8.5	15	11	22	16	28	20	32	24	40	30	37	28	47	35
M10	23	17	29	21	43	32	55	40	63	47	80	60	75	55	95	70
M12	40	29	50	37	75	55	95	70	110	80	140	105	130	95	165	120
M14	63	47	80	60	120	88	150	110	175	130	225	165	205	150	260	109
M16	100	73	125	92	190	140	240	175	275	200	350	225	320	240	400	300
M18	135	100	175	125	260	195	330	250	375	275	475	350	440	325	560	410
M20	190	140	240	180	375	275	475	350	530	400	675	500	625	460	800	580
M22	260	190	330	250	510	375	650	475	725	540	925	675	850	625	1075	800
M24	330	250	425	310	650	475	825	600	925	675	1150	850	1075	800	1350	1000
M27	490	360	625	450	950	700	1200	875	1350	1000	1700	1250	1600	1150	2000	1500
M30	675	490	850	625	1300	950	1650	1200	1850	1350	2300	1700	2150	1600	2700	2000
M33	900	675	1150	850	1750	1300	2200	1650	2500	1850	3150	2350	2900	2150	3700	2750
M36	1150	850	1450	1075	2250	1650	2850	2100	3200	2350	4050	3000	3750	2750	4750	3500

DO NOT use these hand torque values if a different torque value or tightening procedure is given for a specific application. Torque values listed are for general use only and include a $\pm 10\%$ variance factor. Check tightness of fasteners periodically. DO NOT use air powered wrenches.

Shear bolts are designed to fail under predetermined loads. Always replace shear bolts with identical grade.

Fasteners should be replaced with the same grade. Make sure fastener threads are clean and that you properly start thread engagement. This will prevent them from failing when tightening.

When bolt and nut combination fasteners are used, torque values should be applied to the NUT instead of the bolt head.









Tighten toothed or serrated-type lock nuts to the full torque value.

a "Lubricated" means coated with a lubricant such as engine oil, or fasteners with phosphate and oil coatings. "Dry" means plain or zinc plated (yellow dichromate - Specification JDS117) without any lubrication.

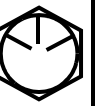
Reference: JDS - G200.

SPECIFICATIONS & INFORMATION FASTENER TORQUES

Inch Fastener Torque Values

SAE Grade and Head Markings	No Marks 	5 	5.1 	5.2 	8 	8.2 
SAE Grade and Nut Markings	No Marks 	5 		8 		

MIF

SIZE	Grade 1				Grade 2b				Grade 5, 5.1 or 5.2				Grade 8 or 8.2			
	Lubricated a		Dry a		Lubricated a		Dry a		Lubricated a		Dry a		Lubricated a		Dry a	
	N•m	lb-ft	N•m	lb-ft	N•m	lb-ft	N•m	lb-ft	N•m	lb-ft	N•m	lb-ft	N•m	lb-ft	N•m	lb-ft
1/4	3.7	2.8	4.7	3.5	6	4.5	7.5	5.5	9.5	7	12	9	13.5	10	17	12.5
5/16	7.7	5.5	10	7	12	9	15	11	20	15	25	18	28	21	35	26
3/8	14	10	17	13	22	16	27	20	35	26	44	33	50	36	63	46
7/16	22	16	28	20	35	26	44	32	55	41	70	52	80	58	100	75
1/2	33	25	42	31	53	39	67	50	85	63	110	80	120	90	150	115
9/16	48	36	60	45	75	56	95	70	125	90	155	115	175	130	225	160
5/8	67	50	85	62	105	78	135	100	170	125	215	160	215	160	300	225
3/4	120	87	150	110	190	140	240	175	300	225	375	280	425	310	550	400
7/8	190	140	240	175	190	140	240	175	490	360	625	450	700	500	875	650
1	290	210	360	270	290	210	360	270	725	540	925	675	1050	750	1300	975
1-1/8	470	300	510	375	470	300	510	375	900	675	1150	850	1450	1075	1850	1350
1-1/4	570	425	725	530	570	425	725	530	1300	950	1650	1200	2050	1500	2600	1950
1-3/8	750	550	950	700	750	550	950	700	1700	1250	2150	1550	2700	2000	3400	2550
1-1/2	1000	725	1250	925	990	725	1250	930	2250	1650	2850	2100	3600	2650	4550	3350

DO NOT use these hand torque values if a different torque value or tightening procedure is given for a specific application. Torque values listed are for general use only and include a $\pm 10\%$ variance factor. Check tightness of fasteners periodically. DO NOT use air powered wrenches.

Shear bolts are designed to fail under predetermined loads. Always replace shear bolts with identical grade.

Fasteners should be replaced with the same grade. Make sure fastener threads are clean and that you properly start thread engagement. This will prevent them from failing when tightening.

When bolt and nut combination fasteners are used, torque values should be applied to the NUT instead of the bolt

head.

Tighten toothed or serrated-type lock nuts to the full torque value.

a "Lubricated" means coated with a lubricant such as engine oil, or fasteners with phosphate and oil coatings. "Dry" means plain or zinc plated (yellow dichromate - Specification JDS117) without any lubrication.

b "Grade 2" applies for hex cap screws (Not Hex Bolts) up to 152 mm (6 in.) long. "Grade 1" applies for hex cap screws over 152 mm (6 in.) long, and for all other types of bolts and screws of any length.

Reference: JDS - G200

SPECIFICATIONS & INFORMATION O-RING SEAL SERVICE

O-Ring Seal Service Recommendations

Face Seal Fittings With Inch Stud Ends Torque

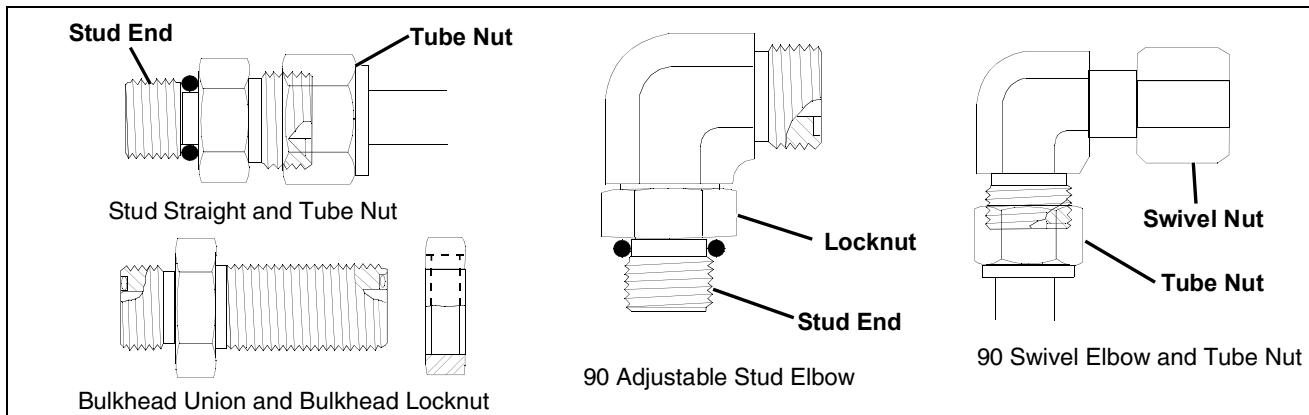

MIF

Nominal Tube OD/Hose ID				Face Seal Tube/Hose End					O-Ring Stud Ends		
Metric Tube OD	Inch Tube OD			Thread Size	Tube Nut/ Swivel Nut Torque		Bulkhead Lock Nut Torque		Thread Size	Straight Fitting or Lock Nut Torque	
	mm	Dash Size	in.		mm	in.	N•m	lb-ft		N•m	lb-ft
5	-3	0.188	4.76						3/8-24	8	6
6	-4	0.250	6.35	9/16-18	16	12	12	9	7/16-20	12	9
8	-5	0.312	7.94						1/2-20	16	12
10	-6	0.375	9.52	11/16-16	24	18	24	18	9/16-18	24	18
12	-8	0.500	12.70	13/16-16	50	37	46	34	3/4-16	46	34
16	-10	0.625	15.88	1-14	69	51	62	46	7/8-14	62	46
19	-12	0.750	19.05	1-3/16-12	102	75	102	75	1-1/16-12	102	75
22	-14	0.875	22.22	1-3/16-12	102	75	102	75	1-3/16-12	122	90
25	-16	1.000	25.40	1-7/16-12	142	105	142	105	1-5/16-12	142	105
32	-20	1.25	31.75	1-11/16-12	190	140	190	140	1-5/8-12	190	140
38	-24	1.50	38.10	2-12	217	160	217	160	1-7/8-12	217	160

NOTE: Torque tolerance is +15%, -20%

SPECIFICATIONS & INFORMATION O-RING SEAL SERVICE

Face Seal Fittings With Metric Stud Ends Torque

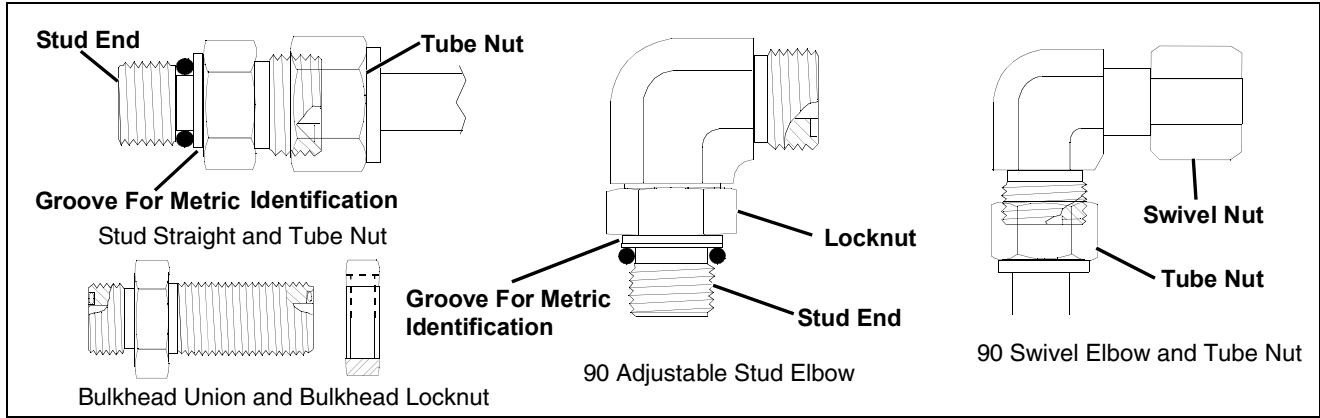

MIF

Nominal Tube OD/Hose ID				Face Seal Tube/Hose End						O-Ring Stud Ends, Straight Fitting or Lock Nut					
Metric Tube OD	Inch Tube OD			Thread Size	Hex Size	Tube Nut/ Swivel Nut Torque		Bulkhead Lock Nut Torque		Thread Size	Hex Size	Steel or Gray Iron Torque		Aluminum Torque	
	mm	Dash Size	in.			mm	in.	mm	N•m			lb-ft	N•m	lb-ft	mm
6	-4	0.250	6.35	9/16-18	17	16	12	12	9	M12X1.5	17	21	15.5	9	6.6
8	-5	0.312	7.94												
										M14X1.5	19	33	24	15	11
10	-6	0.375	9.52	11/16-16	22	24	18	24	18	M16X1.5	22	41	30	18	13
12	-8	0.500	12.70	13/16-16	24	50	37	46	34	M18X1.5	24	50	37	21	15
16	-10	0.625	15.88	1-14	30	69	51	62	46	M22X1.5	27	69	51	28	21
	-12	0.750	19.05	1-3/16-12	36	102	75	102	75	M27X2	32	102	75	46	34
22	-14	0.875	22.22	1-3/16-12	36	102	75	102	75	M30X2	36				
25	-16	1.000	25.40	1-7/16-12	41	142	105	142	105	M33X2	41	158	116	71	52
28										M38X2	46	176	130	79	58
32	-20	1.25	31.75	1-11/16-12	50	190	140	190	140	M42X2	50	190	140	85	63
38	-24	1.50	38.10	2-12	60	217	160	217	160	M48X2	55	217	160	98	72

NOTE: Torque tolerance is +15%, -20%

SPECIFICATIONS & INFORMATION O-RING SEAL SERVICE

O-Ring Face Seal Fittings

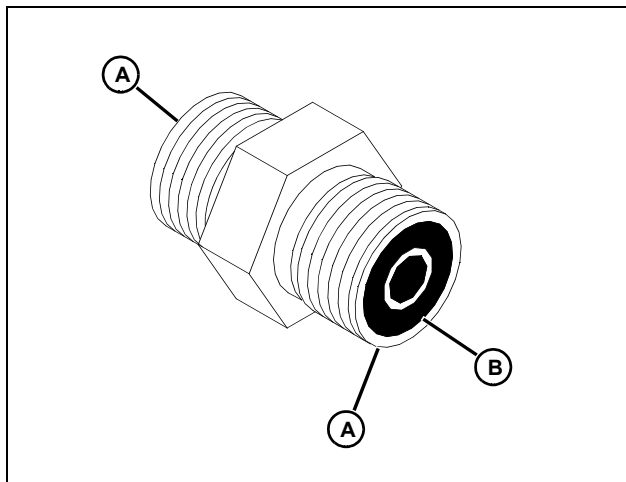

1. Inspect the fitting sealing surfaces (A). They must be free of dirt or defects.
2. Inspect the O-ring (B). It must be free of damage or defects.
3. Lubricate O-rings and install into groove using petroleum jelly to hold in place during assembly.
4. Index angle fittings and tighten by hand pressing joint together to insure O-ring remains in place.

IMPORTANT: Avoid damage! DO NOT allow hoses to twist when tightening fittings. Use two wrenches to tighten hose connections; one to hold the hose, and the other to tighten the swivel fitting.

5. Tighten fitting or nut to torque value shown on the chart per dash size stamped on the fitting.

O-Ring Boss Fittings

1. Inspect boss O-ring boss seat. It must be free of dirt and defects. If repeated leaks occur, inspect for defects with a magnifying glass. Some raised defects can be removed with a slip stone.

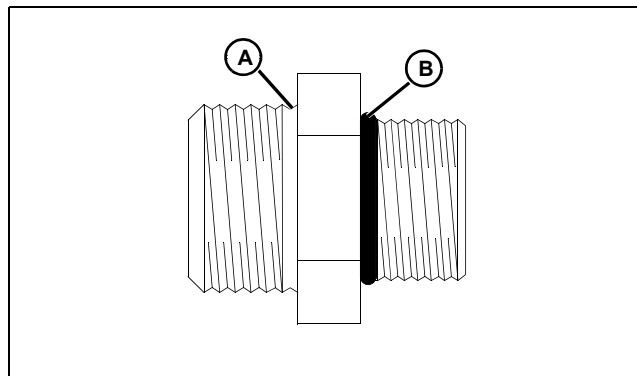

2. Put hydraulic oil or petroleum jelly on the O-ring (B). Place electrical tape over the threads to protect O-ring from nicks. Slide O-ring over the tape and into the groove (A) of fitting. Remove tape.

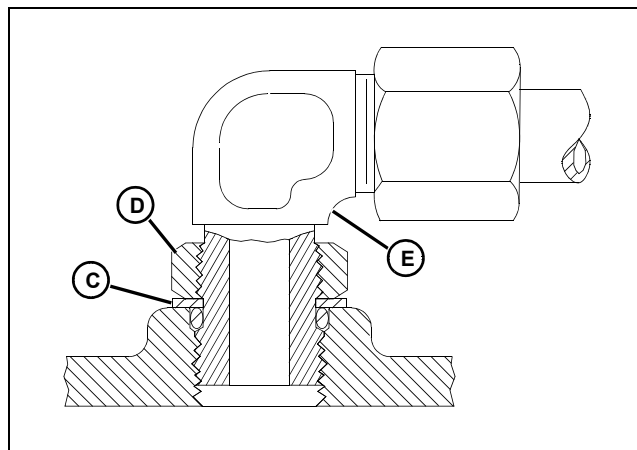

3. For angle fittings, loosen special nut (D) and push special washer (C) against threads so O-ring can be installed into the groove of fitting.
4. Turn fitting into the boss by hand until special washer or washer face (straight fitting) contacts boss face and O-ring is squeezed into its seat.
5. To position angle fittings (E), turn the fitting counter-clockwise a maximum of one turn.
6. Tighten straight fittings to torque value shown on chart. For angle fittings, tighten the special nut to value shown in the chart while holding body of fitting with a wrench.

SPECIFICATIONS & INFORMATION GENERAL INFORMATION

Straight Fitting Or Special Nut Torques

Thread Size	Torque ^a		Number of Flats ^b
	N•m	lb-ft	
3/8-24 UNF	8	6	2
7/16-20 UNF	12	9	2
1/2-20 UNF	16	12	2
9/16-18 UNF	24	18	2
3/4-16 UNF	46	34	2
7/8-14 UNF	62	46	1-1/2
1-1/16-12 UN	102	75	1
1-3/16-12 UN	122	90	1
1-5/16-12 UN	142	105	3/4
1-5/8-12 UN	190	140	3/4
1-7/8-12 UN	217	160	1/2

^aTorque tolerance is ± 10 percent.

^bTo be used if a torque wrench cannot be used. After tightening fitting by hand, put a mark on nut or boss; then tighten special nut or straight fitting the number of flats shown.

Metric Fastener Torque Value - Grade 7 (Special)

Size	Steel or Gray Iron Torque	Aluminum Torque
	N•m (lb-ft)	N•m (lb-ft)
M6	11 (8)	8 (6)
M8	24 (18)	19 (14)
M10	52 (38)	41 (30)
M12	88 (65)	70 (52)
M14	138 (102)	111 (82)
M16	224 (165)	179 (132)

General Information

Gasoline

4 - Cycle Engines



CAUTION: Avoid Injury! Gasoline is HIGHLY FLAMMABLE, handle it with care. DO NOT refuel machine while: indoors, always fill gas tank outdoors; machine is near an open flame or sparks; engine is running, STOP engine; engine is hot, allow it to cool sufficiently first; smoking. Help prevent fires: fill gas tank to bottom of filler neck only; be sure fill cap is tight after fueling; clean up any gas spills IMMEDIATELY; keep machine clean and in good repair - free of excess grease, oil, debris, and faulty or damaged parts; any storage of machines with gas left in tank should be in an area that is well ventilated to prevent possible igniting of fumes by an open flame or spark, this includes any appliance with a pilot light. To prevent fire or explosion caused by STATIC ELECTRIC DISCHARGE during fueling: •ONLY use a clean, approved POLYETHYLENE PLASTIC fuel container and funnel WITHOUT any metal screen or filter.

To avoid engine damage:

- DO NOT mix oil with gasoline;
- **ONLY use clean, fresh unleaded gasoline with an octane rating (anti-knock index) of 87 or higher;**
- fill gas tank at the end of each day's operation to help prevent condensation from forming inside a partially filled tank;
- keep up with specified service intervals.

Use of alternative oxygenated, gasohol blended, unleaded gasoline is acceptable as long as:

- the ethyl or grain alcohol blends DO NOT exceed 10% by volume or
- methyl tertiary butyl ether (MTBE) blends DO NOT exceed 15% by volume

RFG (reformulated) gasoline is acceptable for all machines designed for use of regular unleaded fuel. Older machines (that were designed for leaded fuel) may see some accelerated valve and seat wear.

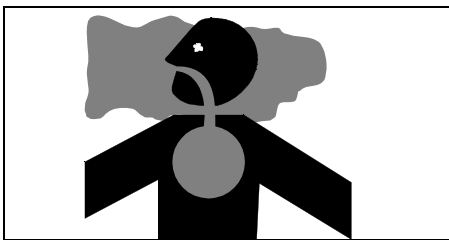

MIF

IMPORTANT: Avoid damage! California Proposition 65 Warning: Gasoline engine exhaust from this product contains chemicals known to the State of California to cause cancer, birth defects, or other reproductive harm.

Gasoline Storage

IMPORTANT: Avoid damage! Keep all dirt, scale, water or other foreign material out of gasoline.

Keep gasoline stored in a safe, protected area. Storage of gasoline in a clean, properly marked ("UNLEADED GASOLINE") POLYETHYLENE PLASTIC container WITHOUT any metal screen or filter is recommended. DO NOT use de-icers to attempt to remove water from gasoline or depend on fuel filters to remove water from gasoline. Use a water separator installed in the storage tank outlet. BE SURE to properly discard unstable or contaminated gasoline. When storing the machine or gasoline, it is recommended that you add **John Deere Gasoline Conditioner and Stabilizer (TY15977)** or an equivalent to the gasoline. BE SURE to follow directions on container and to properly discard empty container.

4 - Cycle Gasoline Engine Oil

Use the appropriate oil viscosity based on the expected air temperature range during the period between recommended oil changes. Operating outside of these recommended oil air temperature ranges may cause premature engine failure.

The following John Deere oils are PREFERRED:

- **PLUS - 4® - SAE 10W-40;**
- **TORQ - GARD SUPREME® - SAE 5W-30.**

The following John Deere oils are **also recommended**, based on their specified temperature range:

- **TURF - GARD® - SAE 10W-30;**
- **PLUS - 4® - SAE 10W-30;**
- **TORQ - GARD SUPREME® - SAE 30.**

Other oils may be used if above John Deere oils are not available, provided they meet one of the following specifications:

- SAE 10W-40 - API Service Classifications SG or higher;
- SAE 5W-30 - API Service Classification SG or higher;
- SAE 10W-30 - API Service Classifications SG or higher;
- SAE 30 - API Service Classification SC or higher.

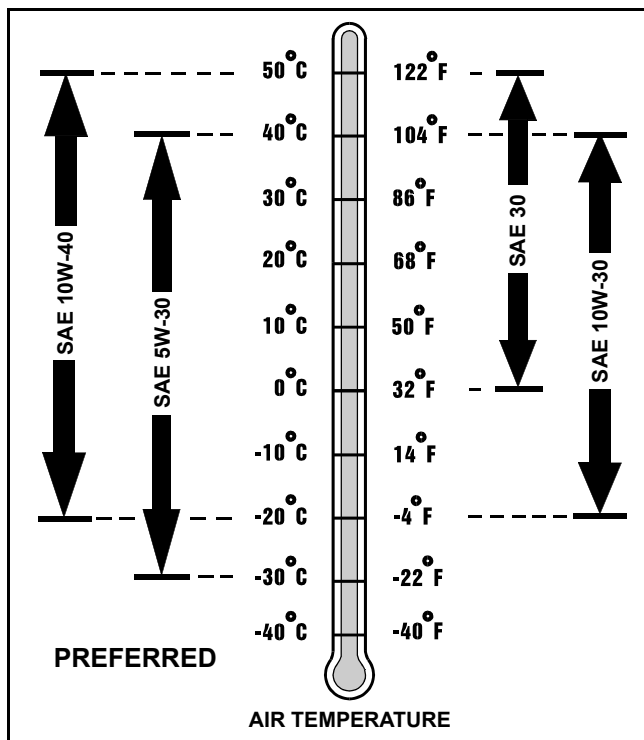

MIF

Diesel Fuel



CAUTION: Avoid Injury! California Proposition 65 Warning: Diesel engine exhaust and some of its elements from this product are known to the State of California to cause cancer, birth defects, or other reproductive harm.

In general, diesel fuels are blended to satisfy the low air temperature requirements of the geographical area in which they are sold.

In North America, diesel fuel is usually specified to **ASTM D975** and sold as either **Grade 1** for cold air temperatures or **Grade 2** for warm air temperatures.

If diesel fuels being supplied in your area **DO NOT** meet any of the above specifications, use diesel fuels with the following equivalent properties:

- **Cetane Number 40 (minimum)**

A cetane number **greater than 50 is preferred**, especially for air temperatures below -20°C (-4°F) or elevations above 1500 m (5000 ft).

- **Cold Filter Plugging Point (CFPP)**

The air temperature at which diesel fuel **begins to cloud or jell** - at least 5°C (9°F) below the expected low air temperature range.

- **Sulfur Content of 0.05% (maximum)**

Diesel fuels for highway use in the United States now require sulfur content to be **less than 0.05%**.

If diesel fuel being used has a sulfur content **greater than 0.05%**, **reduce the service interval for engine oil and filter by 50%**.

Consult your local diesel fuel distributor for properties of the diesel fuel available in your area.

Diesel Fuel Lubricity

Diesel fuel must have adequate lubricity to ensure proper operation and durability of fuel injection system components. Fuel lubricity should pass a **minimum of 3300 gram load level** as measured by the **BOCLE** scuffing test.

Diesel Fuel Storage

IMPORTANT: Avoid damage! DO NOT USE GALVANIZED CONTAINERS - diesel fuel stored in galvanized containers reacts with zinc coating in the container to form zinc flakes. If fuel contains water, a zinc gel will also form. The gel and flakes will quickly plug fuel filters and damage fuel injectors and fuel pumps.

It is recommended that diesel fuel be stored **ONLY** in a clean, approved **POLYETHYLENE PLASTIC** container **WITHOUT** any metal screen or filter. This will help prevent any accidental sparks from occurring. Store fuel in an area that is well ventilated to prevent possible igniting of fumes by an open flame or spark, this includes any appliance with a pilot light.

IMPORTANT: Avoid damage! Keep all dirt, scale, water or other foreign material out of fuel.

Keep fuel in a safe, protected area and in a clean, properly marked (“**DIESEL FUEL**”) container. **DO NOT** use de-icers to attempt to remove water from fuel. **DO NOT** depend on fuel filters to remove water from fuel. It is recommended that a water separator be installed in the storage tank outlet. **BE SURE** to properly discard unstable or contaminated diesel fuel and/or their containers when necessary.

Break-In Engine Oil - 4-Cycle Gasoline

IMPORTANT: Avoid damage! ONLY use a quality break-in oil in rebuilt or remanufactured engines for the first 5 hours (maximum) of operation. DO NOT use oils with heavier viscosity weights than SAE 5W-30 or oils meeting specifications API SG or SH, these oils will not allow rebuilt or remanufactured engines to break-in properly.

The following John Deere oil is **PREFERRED**:

- **BREAK - IN ENGINE OIL.**

John Deere **BREAK - IN ENGINE OIL** is formulated with special additives for aluminum and cast iron type engines to allow the power cylinder components (pistons, rings, and liners as well) to “wear-in” while protecting other engine components, valve train and gears, from abnormal wear. Engine rebuild instructions should be followed closely to determine if special requirements are necessary.

John Deere **BREAK - IN ENGINE OIL** is also recommended for non-John Deere engines, both aluminum and cast iron types.

The following John Deere oil is **also recommended**:

- **TORQ - GARD SUPREME® - SAE 5W-30.**

SPECIFICATIONS & INFORMATION GENERAL INFORMATION

If the above recommended John Deere oils are not available, use a break-in engine oil meeting the following specification during the first **5 hours (maximum)** of operation:

- SAE 5W-30 - API Service Classification SE or higher.

IMPORTANT: Avoid damage! After the break-in period, use the John Deere oil that is recommended for this engine.

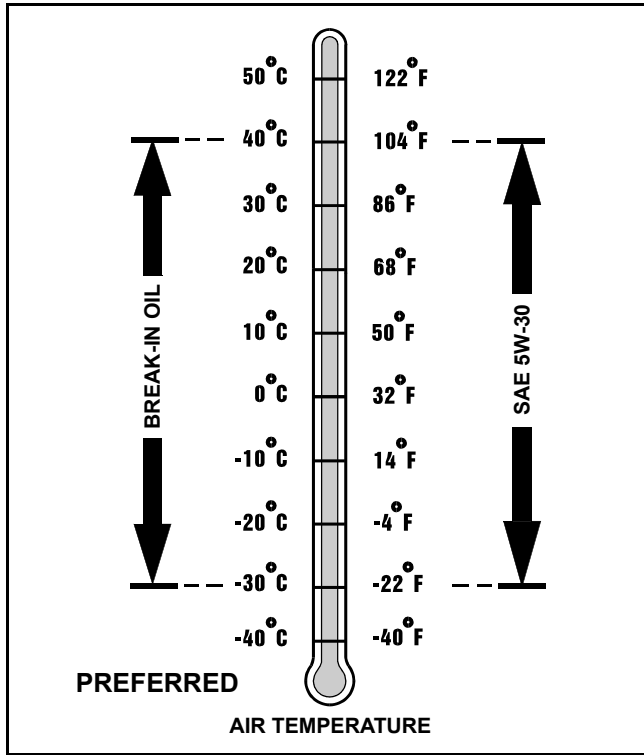

4 - Cycle Diesel Engine Oil

Use the appropriate oil viscosity based on the expected air temperature range during the period between recommended oil changes. Operating outside of these recommended oil air temperature ranges may cause premature engine failure.

The following John Deere oils are PREFERRED:

- PLUS-50® - SAE 15W-40;
- TORQ-GARD SUPREME® - SAE 5W-30.

The following John Deere oils are **also** recommended, based on their specified temperature range:

- TURF-GARD® - SAE 10W-30;
- PLUS-4® - SAE 10W-30;
- TORQ-GARD SUPREME® - SAE 30.

Other oils may be used if above John Deere oils are not available, provided they meet one of the following

specifications:

- SAE 15W-40 - API Service Classifications CF - 4 or higher;
- SAE 5W-30 - API Service Classification CC or higher;
- SAE 10W-30 - API Service Classification CF or higher;
- SAE 30 - API Service Classification CF or higher.

IMPORTANT: Avoid damage! If diesel fuel with sulfur content greater than 0.5% is used, reduce the service interval for oil and filter by 50%.

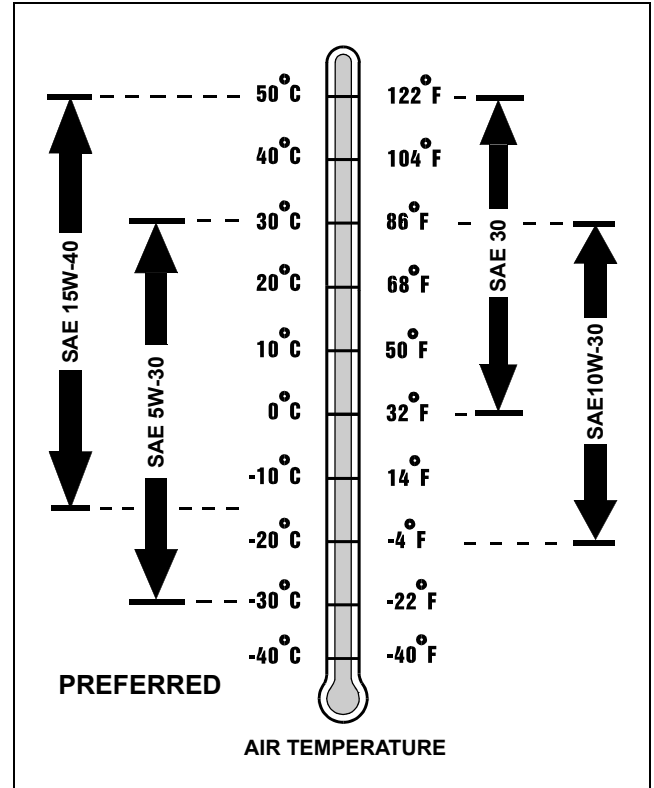

Break-In Engine Oil - Diesel

IMPORTANT: Avoid damage! ONLY use this specified break-in oil in rebuilt or remanufactured engines for the first 100 hours (maximum) of operation. DO NOT use PLUS - 50®, SAE 15W40 oil or oils meeting specifications API CG - 4 or API CF - 4, these oils will not allow rebuilt or remanufactured engines to break-in properly.

The following John Deere oil is PREFERRED:

- **BREAK - IN ENGINE OIL.**

John Deere BREAK - IN ENGINE OIL is formulated with special additives for aluminum and cast iron type engines

SPECIFICATIONS & INFORMATION GENERAL INFORMATION

to allow the power cylinder components (pistons, rings, and liners as well) to “wear-in” while protecting other engine components, valve train and gears, from abnormal wear. Engine rebuild instructions should be followed closely to determine if special requirements are necessary.

John Deere BREAK - IN ENGINE OIL is also recommended for non-John Deere engines, both aluminum and cast iron types.

If this preferred John Deere oil is not available, use a break-in engine oil meeting the following specification during the first 100 hours of operation:

- API Service Classification CE or higher.

IMPORTANT: Avoid damage! After the break-in period, use the John Deere oil that is recommended for this engine.

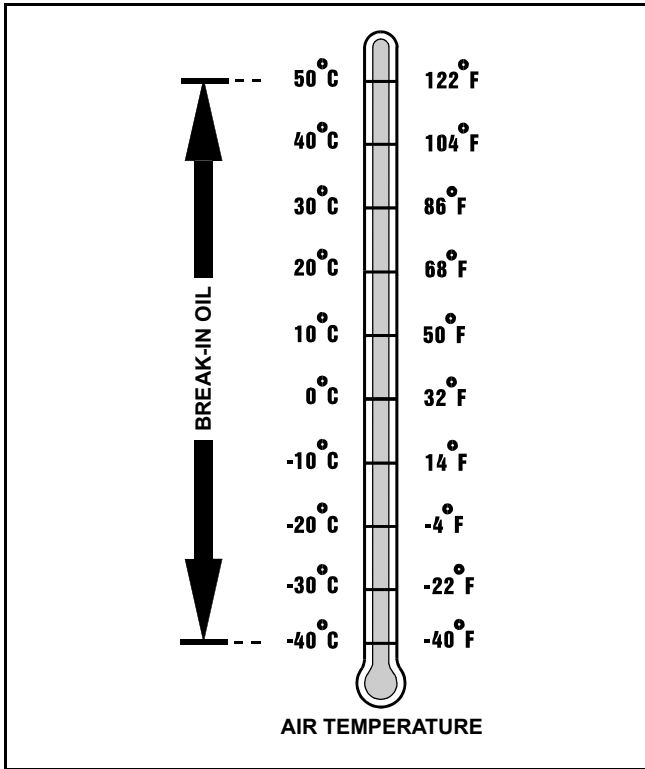

MIF

Hydrostatic Transmission and Hydraulic Oil

Use the appropriate oil viscosity based on these air temperature ranges. Operating outside of these recommended oil air temperature ranges may cause premature hydrostatic transmission or hydraulic system failures.

IMPORTANT: Avoid damage! Mixing of LOW VISCOSITY HY - GARD® and HY - GARD® oils is permitted. DO NOT mix any other oils in this transmission. DO NOT use engine oil or “Type F” (Red) Automatic Transmission Fluid in this transmission. DO NOT use BIO-HY-GARD® in this transmission.

The following John Deere transmission and hydraulic oil is **PREFERRED**:

- **LOW VISCOSITY HY-GARD® - JDM J20D.**

The following John Deere oil is also recommended if above preferred oil is not available:

- **HY-GARD® - JDM J20C.**

Other oils may be used if above recommended John Deere oils are not available, provided they meet one of the following specifications:

- John Deere Standard JDM J20D;
- John Deere Standard JDM J20C.

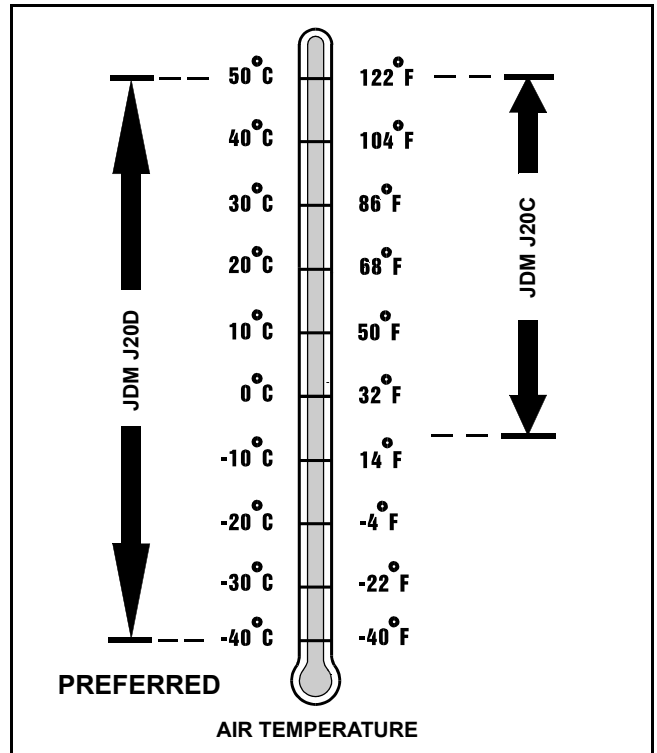

MIF

SPECIFICATIONS & INFORMATION GENERAL INFORMATION

Gear Case Oil

Use the appropriate oil viscosity based on the air temperature ranges. Operating outside of these recommended oil air temperature ranges may cause premature gear case failure.

IMPORTANT: Avoid damage! ONLY use a quality oil in this gear case. DO NOT mix any other oils in this gear case. DO NOT use BIO-HY-GARD® in this gear case.

The following John Deere gear case oil is **PREFERRED**:

- **GL-5 GEAR LUBRICANT® - SAE 80W-90.**

The following John Deere gear case oil is also recommended if above preferred oil is not available:

- **GL-5 GEAR LUBRICANT® - SAE 85W-140.**

Other gear case oils may be used if above recommended John Deere gear case oils are not available, provided they meet the following specification:

- API Service Classification GL - 5.

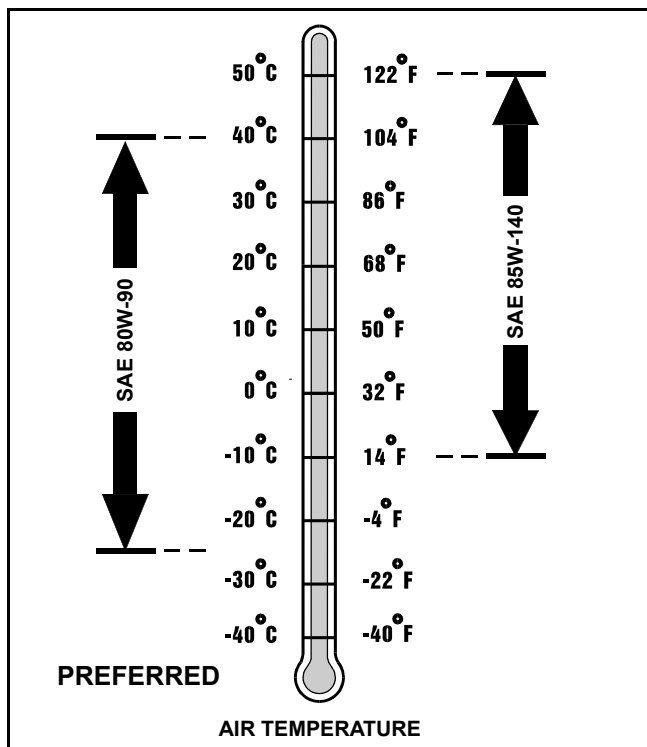

Gear Transmission Grease

Use the following gear grease based on the air temperature range. Operating outside of the recommended grease air temperature range may cause premature gear transmission failure.

IMPORTANT: Avoid damage! ONLY use a quality gear grease in this transmission. DO NOT mix any other greases in this transmission. DO NOT use any BIO - GREASE in this transmission.

The following John Deere gear grease is **PREFERRED**:

- **NON-CLAY HIGH-TEMPERATURE EP GREASE® - JDM J13E4, NLGI Grade 2.**

Other greases may be used if above preferred John Deere grease is not available, provided they meet the following specification:

- John Deere Standard JDM J13E4, NLGI Grade 2.

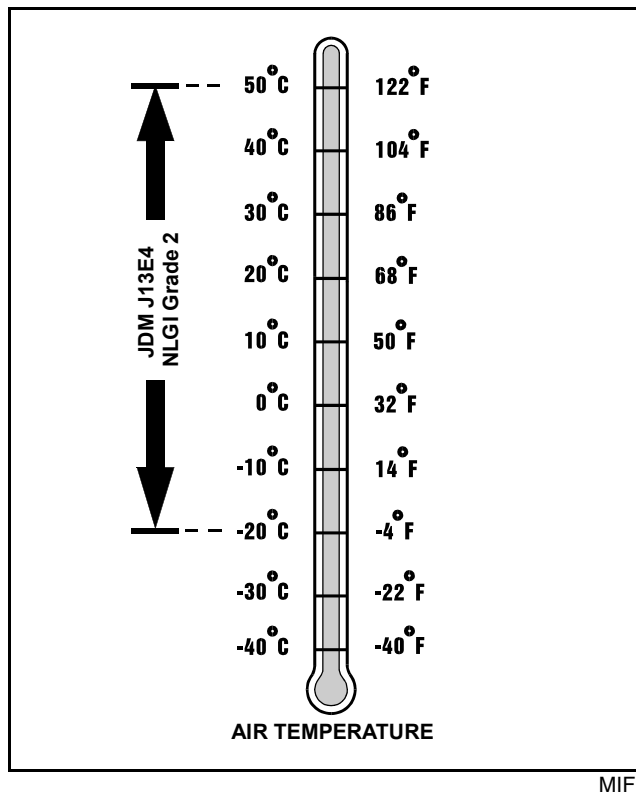

Alternative Lubricants

Use of alternative lubricants could cause reduced life of the component.

If alternative lubricants are to be used, it is recommended that the factory fill be thoroughly removed before switching to any alternative lubricant.

SPECIFICATIONS & INFORMATION COOLANT SPECIFICATIONS

Synthetic Lubricants

Synthetic lubricants may be used in John Deere equipment if they meet the applicable performance requirements (industry classification and/or military specification) as shown in this manual.

The recommended air temperature limits and service or lubricant change intervals should be maintained as shown in the operator's manual, unless otherwise stated on lubricant label.

Avoid mixing different brands, grades, or types of oil. Oil manufacturers blend additives in their oils to meet certain specifications and performance requirements. Mixing different oils can interfere with the proper functioning of these additives and degrade lubricant performance.

Lubricant Storage

All machines operate at top efficiency only when clean lubricants are used. Use clean storage containers to handle all lubricants. Store them in an area protected from dust, moisture, and other contamination. Store drums on their sides. Make sure all containers are properly marked as to their contents. Dispose of all old, used containers and their contents properly.

Mixing of Lubricants

In general, avoid mixing different brands or types of lubricants. Manufacturers blend additives in their lubricants to meet certain specifications and performance requirements. Mixing different lubricants can interfere with the proper functioning of these additives and lubricant properties which will downgrade their intended specified performance.

Oil Filters

IMPORTANT: Avoid damage! Filtration of oils is critical to proper lubrication performance. Always change filters regularly.

The following John Deere oil filters are PREFERRED:

- AUTOMOTIVE AND LIGHT TRUCK ENGINE OIL FILTERS.

Most John Deere filters contain pressure relief and anti-drainback valves for better engine protection.

Other oil filters may be used if above recommended John Deere oil filters are not available, provided they meet the following specification:

- ASTB Tested In Accordance With SAE J806.

Coolant Specifications

Gasoline Engine Coolant

The engine cooling system when filled with a proper dilution mixture of anti-freeze and deionized or distilled water provides year-round protection against corrosion, cylinder or liner pitting, and winter freeze protection down to **-37°C (-34°F)**.

The following John Deere coolant is **PREFERRED**:

- **COOL-GARD® PRE-DILUTED SUMMER COOLANT (TY16036)**.

This coolant satisfies specifications for "Automobile and Light Duty Engine Service" and is safe for use in John Deere Lawn and Grounds Care/Golf and Turf Division equipment, including aluminum block gasoline engines and cooling systems.

The above preferred pre-diluted anti-freeze provides:

- adequate heat transfer
- corrosion-resistant chemicals for the cooling system
- compatibility with cooling system hose and seal material
- protection during extreme cold and extreme hot weather operations
- chemically pure water for better service life
- compliance with ASTM D4656 (JDM H24C2) specifications

If above preferred pre-diluted coolant is not available, the following John Deere concentrate is recommended:

- **COOL-GARD® CONCENTRATED SUMMER COOLANT CONCENTRATE™ (TY16034)**.

If either of above recommended engine coolants are available use any Automobile and Light Duty Engine Service ethylene glycol base coolant, meeting the following specification:

- ASTM D4985 (JDM H24A2).

Read container label completely before using and follow instructions as stated.

SPECIFICATIONS & INFORMATION COOLANT SPECIFICATIONS

IMPORTANT: Avoid damage! To prevent engine damage, DO NOT use pure anti-freeze or less than a 50% anti-freeze mixture in the cooling system. DO NOT mix or add any additives/conditioners to the cooling system in Lawn and Grounds Care/Golf and Turf Division equipment. Water used to dilute engine coolant concentrate must be of high quality - clean, clear, potable water (low in chloride and hardness - Table 1) is generally acceptable. DO NOT use salt water. Deionized or distilled water is ideal to use. Coolant that is not mixed to these specified levels and water purity can cause excessive scale, sludge deposits, and increased corrosion potential.

Property	Requirements
Total Solids, Maximum	340 ppm (20 grns/gal)
Total Hardness, Maximum	170 ppm (10 grns/gal)
Chloride (as Cl), Maximum	40 ppm (2.5 grns/gal)
Sulfate (as SO ₄), Maximum	100 ppm (5.8 grns/gal)

Mix 50 percent anti-freeze concentrate with 50 percent distilled or deionized water. This mixture and the pre-diluted mixture (TY16036) will protect the cooling system down to **-37°C (-34°F)** and up to **108°C (226°F)**.

Certain geographical areas may require lower air temperature protection. See the label on your anti-freeze container or consult your John Deere dealer to obtain the latest information and recommendations.

Gasoline Engine Coolant Drain Interval

When using John Deere Pre-Diluted (TY16036) Automobile and Light Duty Engine Service coolants, drain and flush the cooling system and refill with fresh coolant mixture every 36 months or 3,000 hours of operation, whichever comes first.

When using John Deere Concentrate (TY16034) Automobile and Light Duty Engine Service coolants, drain and flush the cooling system and refill with fresh coolant mixture every 24 months or 2,000 hours of operation, whichever comes first.

If above John Deere Automobile and Light Duty Engine Service coolants are not being used; drain, flush, and refill the cooling system according to instructions found on product container or in equipment operator's manual or technical manual.

Diesel Engine Coolant

The engine cooling system when filled with a proper dilution mixture of anti-freeze and deionized or distilled water provides year-round protection against corrosion, cylinder or liner pitting, and winter freeze protection down to **-37°C (-34°F)**.

The following John Deere coolant is **PREFERRED**:

- **PRE-DILUTED DIESEL ENGINE ANTI-FREEZE/SUMMER COOLANT™ (TY16036).**

This coolant satisfies specifications for "Automobile and Light Duty Engine Service" and is safe for use in John Deere Lawn and Grounds Care/Golf and Turf Division equipment, including aluminum block gasoline engines and cooling systems.

The above preferred pre-diluted anti-freeze provides:

- adequate heat transfer
- corrosion-resistant chemicals for the cooling system
- compatibility with cooling system hose and seal material
- protection during extreme cold and extreme hot weather operations
- chemically pure water for better service life
- compliance with ASTM D4656 (JDM H24C2) specifications

If above preferred pre-diluted coolant is not available, the following John Deere concentrate is recommended:

- **DIESEL ENGINE ANTI-FREEZE/SUMMER COOLANT CONCENTRATE™ (TY16034).**

If either of above recommended engine coolants are available use any Automobile and Light Duty Engine Service ethylene glycol base coolant, meeting the following specification:

- ASTM D3306 (JDM H24C1).

Read container label completely before using and follow instructions as stated.

SPECIFICATIONS & INFORMATION SERIAL NUMBER LOCATIONS

IMPORTANT: Avoid damage! To prevent engine damage, DO NOT use pure anti-freeze or less than a 50% anti-freeze mixture in the cooling system. DO NOT mix or add any additives/conditioners to the cooling system in Lawn and Grounds Care/Golf and Turf Division equipment. Water used to dilute engine coolant concentrate must be of high quality - clean, clear, potable water (low in chloride and hardness - Table 1) is generally acceptable. DO NOT use salt water. Deionized or distilled water is ideal to use. Coolant that is not mixed to these specified levels and water purity can cause excessive scale, sludge deposits, and increased corrosion potential.

Property	Requirements
Total Solids, Maximum	340 ppm (20 grns/gal)
Total Hardness, Maximum	170 ppm (10 grns/gal)
Chloride (as Cl), Maximum	40 ppm (2.5 grns/gal)
Sulfate (as SO ₄), Maximum	100 ppm (5.8 grns/gal)

Mix 50 percent anti-freeze concentrate with 50 percent distilled or deionized water. This mixture and the pre-diluted mixture (TY16036) will protect the cooling system down to -37°C (-34°F) and up to 108°C (226°F).

Certain geographical areas may require lower air temperature protection. See the label on your anti-freeze container or consult your John Deere dealer to obtain the latest information and recommendations.

Diesel Engine Coolant Drain Interval

When using John Deere Pre-Diluted (TY16036) Automobile and Light Duty Engine Service coolants, drain and flush the cooling system and refill with fresh coolant mixture every 36 months or 3,000 hours of operation, whichever comes first.

When using John Deere Concentrate (TY16034) Automobile and Light Duty Engine Service coolants, drain and flush the cooling system and refill with fresh coolant mixture every 24 months or 2,000 hours of operation, whichever comes first.

If above John Deere Automobile and Light Duty Engine Service coolants are not being used; drain, flush, and refill the cooling system according to instructions found on product container or in equipment operator's manual or technical manual.

Serial Number Locations

Product Serial Number

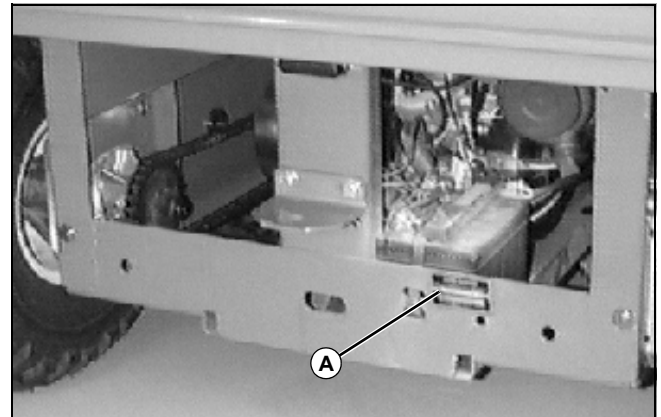

M55706

The product identification number (A) is located on the rear of the frame.

Engine (FE290D) Serial Number Location

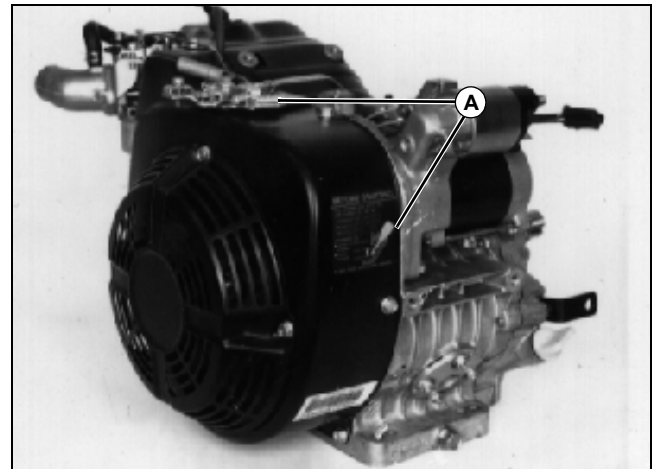

M80501

Engine serial number (A) can be located on either the top or side of blower housing.

SPECIFICATIONS & INFORMATION SERIAL NUMBER LOCATIONS

Engine (FE620D) Serial Number Location



M55793

Engine (3TN66C) Serial Number Location

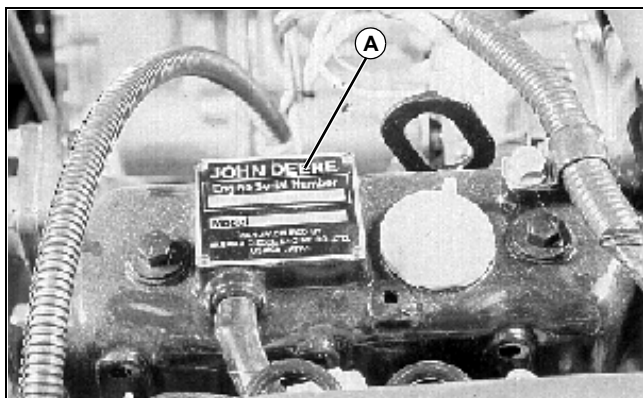

M76678

Transaxle Serial Number Location

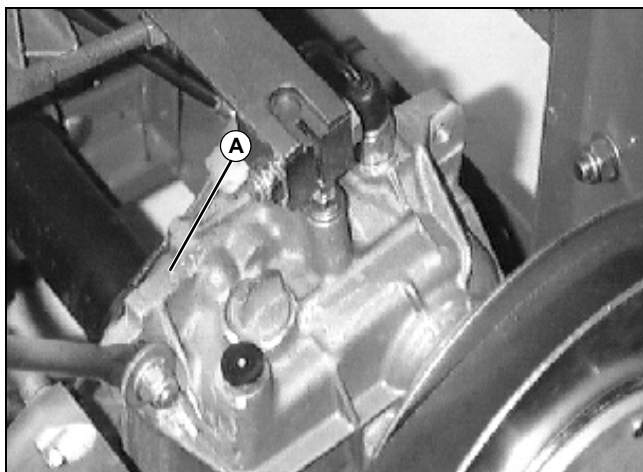

M55707



ENGINE - GAS (AIR-COOLED) TABLE OF CONTENTS

Table of Contents

Specifications27

General Specifications	27
Test and Adjustment Specifications	27
Repair Specifications.....	28
Special or Essential Tools	31
Other Materials.....	31

Component Location.....32

FE290D Engine.....	32
Carburetor Components.....	33
Starter Motor Components	35

Diagnostics36

Engine Troubleshooting Guide.....	36
Starting Motor Troubleshooting Guide	37

Tests and Adjustments38

Governor Adjustment	38
Choke Cable Adjustment.....	38
Slow Idle Mixture Screw and Speed Adjustments	39
Fast Idle Speed Adjustment	40
Throttle Cable Adjustment.....	41
Pedal Stop Adjustment.....	42
Fuel Pump Pressure Test.....	42
Fuel Pump Flow Test	43
Fuel Tank Gauge Test.....	43
Fuel Tank Check Valve Test	44
Cylinder Compression Test	44
Valve Clearance Adjustment	45
Automatic Compression Release (A.C.R.) Test	46
Crankcase Vacuum Test.....	46
Oil Pressure Test.....	47
Alternator Drive Belt Adjustment	48
Air Intake System Check	49

Repair.....50

Muffler Removal and Installation	50
Engine Removal and Installation.....	50
Carburetor Removal and Installation.....	51
Carburetor Disassembly and Assembly	52
Crankcase Breather Inspection	52
Blower Housing Removal and Installation	53
Flywheel Removal and Installation.....	53
Rocker Arm Removal and Installation	54
Rocker Arm Inspection	54

Cylinder Head Removal and Installation	54
Cylinder Head Disassembly and Assembly	55
Cylinder Head Inspection and Replacement	55
Recondition Valve Seats.....	57
Lap Valves.....	58
Crankcase Cover Removal and Installation	58
Camshaft Removal and Installation.....	58
Camshaft Inspection	59
Automatic Compression Release	60
Tappets Inspection and Replacement.....	60
Piston and Connecting Rod.....	60
Reciprocating Balancer.....	63
Crankshaft Removal and Installation.....	64
Crankshaft Inspection.....	64
Crankshaft End Play Check.....	65
Analyze Crankshaft and Connecting Rod Wear	65
Crankshaft End Play Adjustment.....	65
Crankshaft Oil Seal - Flywheel End Replacement.....	66
Crankshaft Oil Seal - PTO End Replacement.....	66
Governor Shaft Oil Seal Replacement.....	66
Cylinder Block Inspection	66
Cylinder Deglazing.....	67
Cylinder Boring.....	67
Oil Pump Disassembly and Assembly	68
Oil Pump Inspection.....	68
Oil Filter Manifold Removal and Installation	69
Governor Inspection and Replacement.....	70
Governor Shaft Inspection and Replacement	70
Armature With Coil Removal and Installation	70
Ignitor Replacement.....	71
Stator Removal and Installation.....	71
Starting Motor	71
Recoil Starter Disassembly and Assembly.....	73
Recoil Starter Spring Replacement	73

ENGINE - GAS (AIR-COOLED) TABLE OF CONTENTS



ENGINE - GAS (AIR-COOLED) SPECIFICATIONS

Specifications

General Specifications

Make	Kawasaki
Model	FE290D-BS08
Type	4-cycle gas/Air cooled
Power	7.46 kW (10 hp)
Cylinders	1
Cycles	4
Bore	78 mm (3.070 in.)
Stroke	60 mm (2.360 in.)
Displacement	286 cm ³ (17.5 cu-in.)

Test and Adjustment Specifications

Engine:

Oil pressure (minimum)	314 kPa (46 psi)
Oil filter bypass valve opening pressure	78 - 118 kPa (11.3 - 17.0 psi)
Compression pressure at operating temperature (minimum)	393 kPa (57 psi)
Compression pressure at operating temperature (maximum)	965 kPa (140 psi)
Crankcase vacuum (minimum)	25 mm (1 in.) water movement
Intake and exhaust valve clearance (cold)	0.125 ± 0.025 mm (0.005 ± 0.001 in.)
Intake and exhaust valve adjustment interval	300 hrs
Valve clearance adjusting nut torque	20 N•m (180 lb-in.)
Auto Compression Release minimum lift	0.6 mm (0.023 in.)
Auto Compression Release standard lift	1.2 mm (0.047 in.)
Auto Compression Release release rpm	.600 ± 100 rpm
Breather reed valve tip air gap	0.2 mm (0.008 in.)
Valve cover cap screw torque	6 N•m (53 lb-in.)

Fuel/Air System:

Fuel Pump

Minimum Pressure	6.12 kPa (0.9 psi)
Minimum Flow	80 ml (2.7 oz) in 15 seconds
Carburetor SLOW idle mixture screw initial setting (PIN -12700) with no limiter cap	1-3/8 Turns
Throttle control arm SLOW idle stop screw setting	1125 ± 75 rpm
Carburetor SLOW idle stop screw setting . . .	50 rpm less than throttle control arm SLOW idle stop screw setting
Throttle control arm FAST idle stop screw setting (S.N. - 345211)	3750 ± 100 rpm
Throttle control arm FAST idle stop screw setting (S.N. 345212-)	3850 ± 75 rpm
Fuel tank check valve (PIN -14950) maximum opening pressure	3 kPa (0.4 psi)

ENGINE - GAS (AIR-COOLED) SPECIFICATIONS

Repair Specifications

Miscellaneous Repair Specifications

Breather Maximum Air Gap	0.20 mm (0.008 in.)
Flywheel Nut Torque	85 N•m (63 lb-ft)

Cylinder Head Assembly

Cylinder Head Flatness	0.05 mm (0.002 in.)
------------------------------	---------------------

Cap Screw Torque

First	18 N•m (159 lb-in.)
Second	21 N•m (186 lb-in.)
Final	24 N•m (212 lb-in.)
Spark Plug Torque	25 N•m (221 lb-in.)

Rocker Arm:

Minimum Shaft OD	11.95 mm (0.470 in.)
Maximum Bearing ID	12.07 mm (0.475 in.)

Push Rod:

Maximum Bend	0.30 mm (0.012 in.)
--------------------	---------------------

Valves and Springs:

Valve Clearance	0.127 mm (0.005 in.)
Valve Seat Width	0.50 - 1.10 mm (0.020 - 0.043 in.)

Intake and Exhaust Valves

Maximum Bend	0.03 mm (0.0012 in.)
Minimum Valve Face Margin	0.060 mm (0.024 in.)
Valve Stem OD (Wear Limit)	
Intake Valve	6.930 mm (0.2728 in.)
Exhaust Valve	6.915 mm (0.2722 in.)

Valve Guides

Maximum Guide ID	7.065 mm (0.2781 in.)
Finished (Reamed) ID	7.00 - 7.015 mm (0.2756 - 0.2762 in.)
Valve Springs Minimum Free Length	32.75 mm (1.289 in.)

Valve Seat - Recondition

Valve Face Angle45°
Valve Margin	0.60 mm (0.020 in.)
Valve Narrowing Angle30°
Valve Seat Angle45°
Valve Seating Surface Width	0.50 - 1.10 mm (0.020 - 0.043 in.)

Thanks very much for your
reading, Want to get more
information, Please click
here, Then get the complete
manual

Just**ClickHere**

NOTE:

**please download the PDF
document first, and then click
on it.**